



ACHI[®]
IR6500

BGA Rework Station

User Manual

Beijing Technican Technology Co., LTD.

- **preface**
- I. Brief introduction to company**
- II. IR6500 and IR6000 comparison**
- **Safety Instrouctions**
- I. Electric Safety**
- II. Operation Safety**
- III. The operation and conservation condition of products**
- **Our contact information**
- **product guarantee and so on**
- **The parameters of IR6500 BGA Rework Station**
- **hardware description and Self-help install**
- **temperature-controlled meter Operation instructions**
- **temperature control software instructions**
- **BGA Rework operation steps**
- **Prompt**

Brief introduction to company

Beijing Technican Technology Co., LTD.is a manufacturing enterprise specializes in BGA manual Reworks equipment research, development and production.

ACHI® and **亚琪®** is our company's registered brand. Based on the principles of producing high-quality and cost-effective welding equipment, our company has developed and produced a number of BGA Rework Stations, such as **IR900**、**IR-3**、**IR3000**、**IR-PRO**、**IR6000**、**IR-PRO-SC** etc.,and has been recognized by the majority of users in practice. So far, our users have been involved in scientific research units, computer maintenance and repair of medical equipment, communications equipment maintenance, video game maintenance, training teaching, and other fields.

We also produce and operate some assistant and materials of manual BGA welding, such as customized BGA Reballing Template, solder ball, Flux,etc.,to help users streamline operation, improve the success rate of welding, and reduce welding costs.

In the future, our company will continue serving users with sophisticated products, reasonable price, high quality, and continuously innovating and upgrading product structure and performance according to market, for meeting the developing needs of our users, and providing the users with systemic, comprehensive and thoughtful services.

ACHI® IR6500 were retrofitted and upgraded on the basis of **ACHI®IR6000**. have the following characteristics:

- 1、**IR6500** Rework station for laptop motherboards, desktop computer motherboards, server boards, industrial computer boards, all kinds of game boards, communications equipment motherboards, LCD TVs and other large circuit board BGA rework
- 2、**IR6500** Innovative designs .an effective solution to general of infrared rework station vulnerable to the impact of air flow. will lead an inaccurate of temperature control. can easily deal with lead-free soldering rework.
- 3、**IR6500** can set up 8 rising temperature segments and 8 constant temperature segments to control. It can save 10 groups of temperature curves at one time.
- 4、**IR6500** can be connected to a computer to be controlled more conveniently with a built-in USB connector and proprietary Software attached to it. programmable
- 5、**IR6500** can easily rework the variety of CPU's seat, all kinds of shielding enclosures, replacement of various components slot。 can easily deal with lead-free soldering rework
- 6、**IR6500** sensitive temperature measurement sensor to obtain an accurate and instantaneous temperature reading and monitoring。
- 7、**IR6500** BGA rework station the technology of closed-loop temperature control ensures accurate temperature process and even heat distribution.
- 8、**IR6500** Machine overall system integration Design, Rework station more integrated workbench area occupied by smaller, Didn't mixed and disorderly of cables.
- 9、**IR6500** Linear guide type Bracket with abnormity pole。 can be locking 、 adjusted by rotating the handle, can be very easily fixed PCB board, effectively prevent the deformation of PCB board.

ACHI® IR6500 and IR6000 comparison

1、Temperature Sensor:

IR6000: probe-type sensor

IR6500 :Soft OMEGA Thermocouple Wire

OMEGA Thermocouple Wire is more accurate, and more flexible to locate on main boards.

CAUTION: the thermocouple wire should be placed in the right position while heating, to avoid top heater get burned because the top temperature out of control.

2. Bottom heating panel

IR6000: nets bareness type

IR6500: closed panel

Closed panel is safer and can be cleaned.

CAUTION: You cannot clean the panel until the high temperature cooling down to room temperature.

3、Power Switch:

IR6000: common button switch

IR6500: safe air-break switch

Safe air-break switch is safer and offer overload/ short circuit protection.

4、Connector:

IR6000, RS232 connector

IR6500, USB connector

USB connector is more convenient and support hot swappable.

CAUTION: Need to install the USB interface driver in the CD.

5、Bottom Heating Controller

IR6000: CH6 controller

IR6500: 8000 controller

8000 controller, temperature is more accurate, and temperature setting is much more easy.

6、PCB Jig

IR6000 :standard jig

IR6500 :standard jig+ 4 pcs abnormity pole

The abnormity pole is more convenient to fixture irregular board, and can use transverse tension to prevent motherboard deformation.

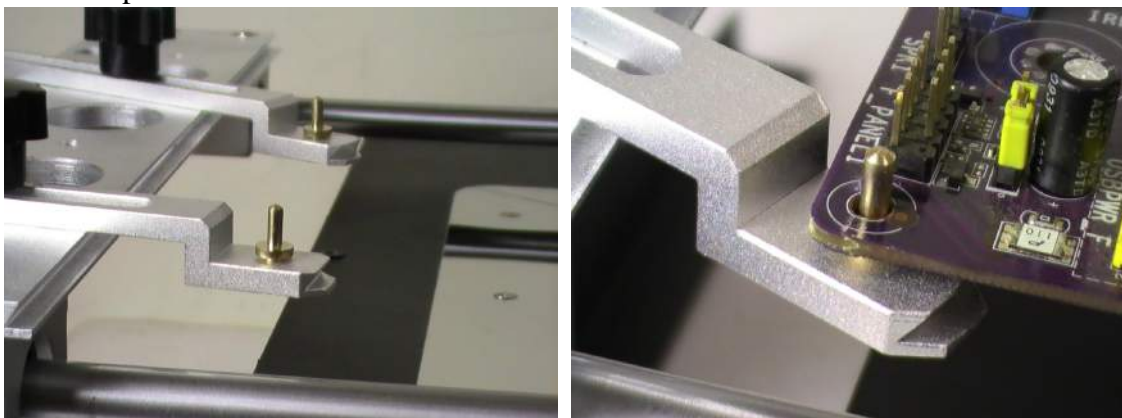

Safety Instructions

I .Electrical safety

- Make sure the supply power voltage accord with the standards 220V/50hz alternating current before installing.
- To avoid possible electric shock caused serious damage, please disconnect the power cord from the outlet temporary before moving machines.
- If the machine damages, please contact us for maintenance. If the damage caused by the users when they dismantle or repair independently, they should take on the loss by themselves.

II . Operating safety

- Please carefully read the relevant information provided by the manual before starting using this product.
- Make sure the power cord has been properly connected properly before using the products.
- Installed the equipment in stable work platform to use, where the air mobility should be small as possible. Avoid it closing to air conditioners, fans and the other outlet.
- In case of electrical short-circuit, avoid the products contacting with water.
- Forbid using this equipment in flammable and explosive substances.
- The operators' hands or other parts of the body should maintain a safe distance from the heater. Forbid touching the heater to avoid scalding.
- If you have any technical questions or suggestions in the course of using this product, please contact with our technology department. We will try our best to solve.

III.Environmental requirements of operation and conservation

1. Operation environment of products

- Operation temperature:15 ~ 45 °C
- Operation humidity:5% to 95%, non-condensing
- Products should be kept in the air mobility of a smaller environment under the welding operation.

2.Conservation environment of products

- Storage temperature:-20 ~ 70 °C
- Storage humidity: 5% to 95%, non-condensing

Contact us

Add: Room 8009,
1 Xicaochang Road
Haidian District
Beijing 100080
The People's Republic Of China
Sales Support: 86-10-82853468 (Chinese Speaking)
Technology Support: 86-10-82851031(Chinese Speaking)
MSN: easybga@gmail.com
URL.: <http://www.easybga.com>

product guarantee and so on

Service Statement:

- Enjoy warranty maintenance service for three years,in which the service in the first year is free.And the transport costs arise from maintenance should be paid by the buyers since purchased..
- Only the actual cost of spare parts should be paid from the beginning of the second year(the 13th month)to the end of the third year (the 36th month) since purchased. Please call to ask the specific prices of spare parts.And the transport costs arise from maintenance should be paid by buyers.
- Each product corresponds to the only serial number,the serial number bar code,the warranty certificate ,affixed the fixed position of the machinery,.



- Please contact your vendor. if fault happen.
If the following situations occered,the users will not be entitled to free warranty service,then the maintenance,the cost of materials and the man-hour will be charged.

So to ensure your rights, please read the following note carefully:

- No serial number bar code or damaged serial number bar code.
- Cause damage for not use,keep and storage as the manual.
- Cause internal and external appearance damage by modify or outside force.
- Product was deformed or lost components.
- Change product components without our authorization for maintenance.
- Beyond the warranty period of our promises..
- Product damage were caused by irresistible external factors(such as natural factors, earthquakes,lightning strikes,etc.)

Note: Do not disassemble it by yourself,it may cause the invalidation of product guarantee. . We reserve the final identification right of the product fault.

The parameters of ACHI® IR6500 BGA Rework Station

Basic Parameters	
Heating	IR
Dimension	L 475mm×W480mm×H420 mm
Weight	15kg
Total weight	About 17 kg, vary with the differen need of the users
Electrical Parameters	
Power	220V AC
Upper Heating	IR
Size of Upper heating	80mm×80 mm
Consumption of upper heating	400W
Bottom Heating	IR
Size of Bottom heating	180 mm×180 mm
Consumption of Bottom heating	800W
General power	1250W
Temperature Control	
Control mode of Upper	Independent temperature control, high-precision closed-loop control, precision ± 0.5%, Alarm
Control mode of Bottom	Independent temperature control, high-precision closed-loop control, precision ± 0.5%, NO Alarm
Rework Function	
SMD	Suit for welding, remove or repair packaged devices such as BGA,PBGA,CSP,multi-layer substrates, EMI metallic shield product and solder/lead free Rework 、welding
Size of applicable chips	≤70mm×70 mm
Size of applicable PCB	≤400mm×305 mm

Hardware description

ACHI® IR6500 BGA Rework Station is composed of upper part of Heating Components / Bottom Preheat Module / Bracket / Temperature Control Parts! Temperature control Table is control the upper and lower heating, Can Simultaneously heated or first preheat, then the upper part of heating.

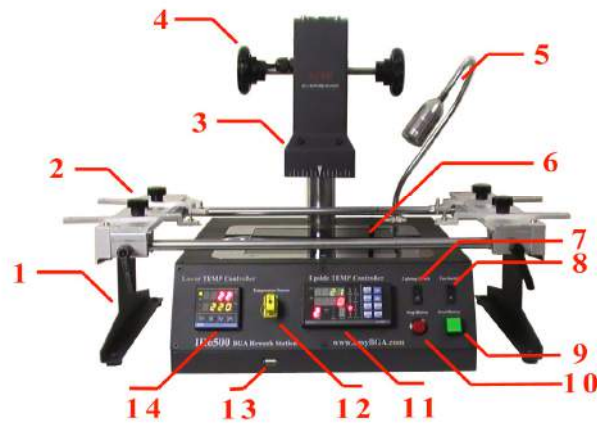

1. PCB Table
2. Abnormity pole
3. Upside Heater
4. X-Y Lifting Regulator
5. LED Auxiliary Lighting
6. Bottom Heater (Pre-Heater)
7. Lighting Switch
8. Upper fan Switch
9. Start Switch
10. Stop Switch
11. Upper Programmable Temperature Controller
12. Highly Sensitive K-temperature sensor
13. USB interface
14. Bottom Temperature Controller

Self-help Install

PCB Table

1. Installation side support.



2. Installation Slip.



3. Installation side support.



Upper Heater

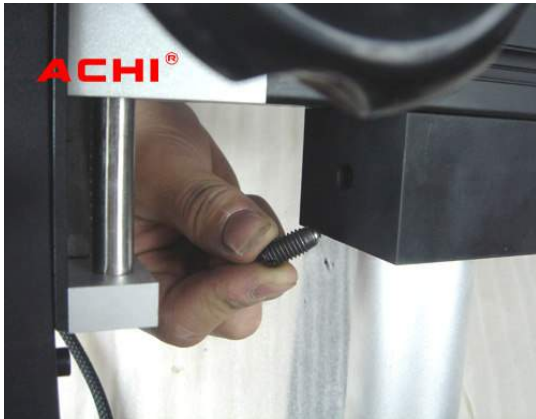
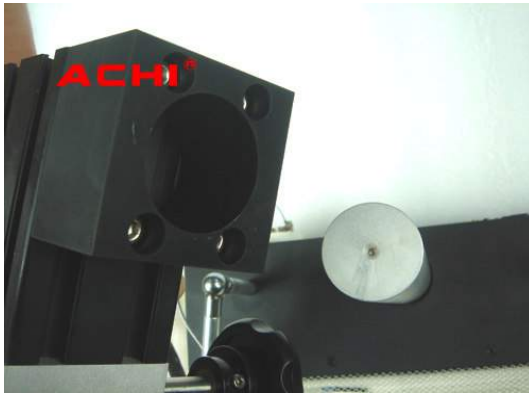

Cable connector



Temperature sensor



Installation of USB interface



Install the driver and IRsoft

● Install the USB Driver

1、



2、



3、Settings for Prot :

CAUTION: COM port Number must is configured to use the COM1.

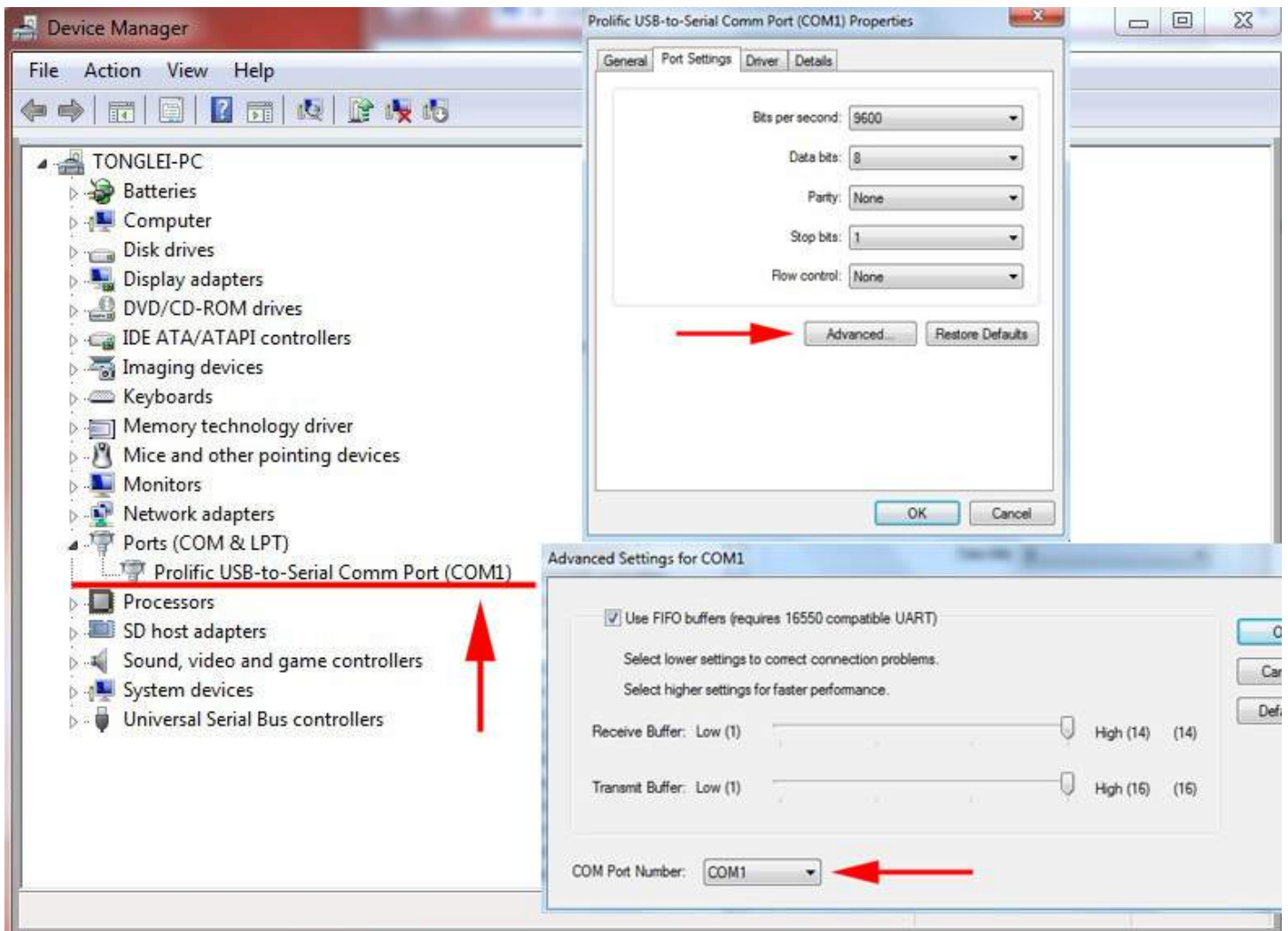

4、Install the IRsoft



Programmer/Controller General Description

The programmable controller contains an in-built setpoint generator in addition to the controller function. This setpoint generator can produce a temperature/time profile with 10*16 segments (0~9, 10 Sets of Curves). When the program is running, the current setpoint from the setpoint generator is fed to the control algorithm. The current setpoint is continuously shown on the lower display.

The sixteen segments are defined in the order: Ramp 1, Dwell period 1, Ramp 2, Dwell period 2..., and are executed in succession.

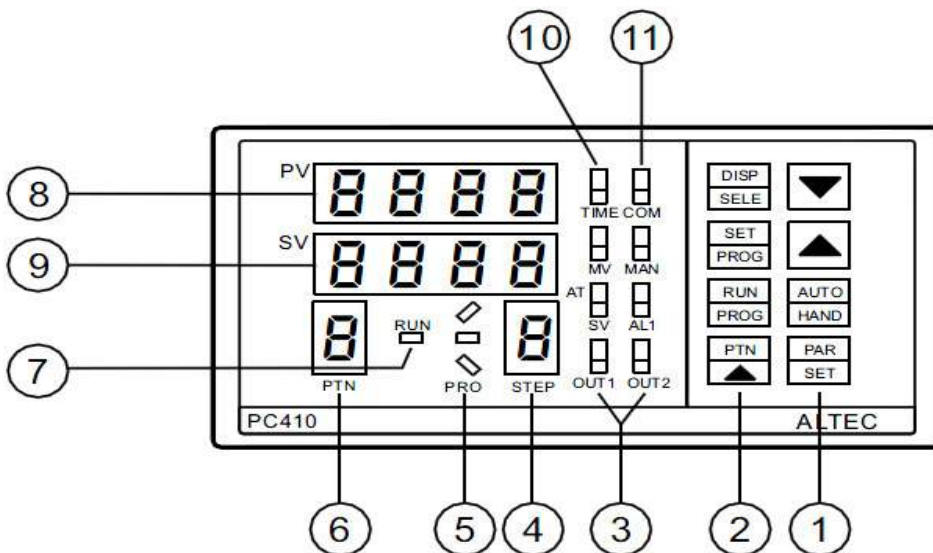

S.N.	Item	Functions
①		Parameters setting key
		(Up key) Increase value
		(Down key) Decrease value
②		Selects the program pattern number
		Starts/hold the program, changes the mode from fixed value control to program control
		Program parameters setup
		Changes the indication on SV/MV/TIME display
③	OUNT	Output indicator
④	STEP	Indicates the step number of program
⑤	PRO	(Program monitor indicator) During program control, ‘/’ is lit when the PV is rising During program control, ‘-’ is lit when the PV is constant During program control, ‘\’ is lit when the PV is falling
⑥	PTN	(Pattern number display) Indicates the pattern number ‘0~9’
⑦	RUN	(Program control running indicator)

		The LED indicator is lit during program control
⑧	PV	(PV Display) Indicates the Process/Measured value
⑨	SV	It is lit when the Setting Value(SV) is being displayed on the lower display
⑩	TIME MV SV	(SV/MV/TIME display) It indicates the Setting Value(SV), Manipulating Value(MV), or Time(TIME) (The display content can be changed by the 'DISP/SELECT' key)
⑪	AL1	It is lit when the Alarm1 output is 'ON'
	COM	(Communication indicator) It flashes when the controller is in active communication with a host computer

● Program Parameters Setting

Ramp Rate1: $r1$

A ramp consists of a slope(linear gradient) and a target setpoint. The control setpoint increases or decreases at a linear ramp rate from the actual measured value until a specified target setpoint is reached. The relative positions of the actual measured value and the target setpoint determine whether the slope of the ramp is positive or negative. Parameters R1, R2, R3... express the ramping rate in unites per minute(0.01~99.99), parameters L1, L2, L3... the appropriate target setpoint in display units.

If $R1 = \text{END}$, the program will be ended when the program runs to the slope.

Target Setpoint 1: $L1$

The target value to which the setpoint ramps when the programmer has been placed into RVN.

Dwell period 1:

In a Dwell period, the target setpoint, which has been attained, remains unchanged for a fixed period. All the dwell periods are defined by their duration in minutes with parameters D1, D2, D3...(0~9999). When the program is running, these parameter display the time remaining in the active dwell period. If the parameter equals zero, the dwell period is skipped.

When the controller runs in the **PV** displaying status:

- 1). Select the target program pattern number with the **PTN/** key.
 - 2). press **SET/PROG** key, the first program parameter appears in the upper display. The value associated with this parameter will be shown in the lower display.
 - 3). Use **▲** and **▼** key to modify the value.
 - 4). Press the **PAR/SET** key, the next parameter appears. At the same time, the modification has been saved in the memory. Use **▲** and **▼** key to modify the value.
- Repeat this procedure till all the parameters are set. Or if there is no key operation within 16 seconds, the menu times out automatically.

Program Parameter List

S.N.	Mnemonic	Parameter	Adjustable Range
1	Lc	Program Loop Counter	1~200, <i>cont</i> (continuous)
2	ri	Ramp Rate 1	<i>End</i> ; <i>StEP</i> ; 0.01~99.99 units/(min, sec)
3	Li	Target Setpoint 1	$SP_L \sim SP_H$
4	di	Dwell Time 1	0 ~ 9999 min
5	$r2$	Ramp Rate 2	<i>End</i> ; <i>StEP</i> ; 0.01~99.99 units/(min, sec)
6	$L2$	Target Setpoint 2	$SP_L \sim SP_H$
7	$d2$	Dwell Time 2	0 ~ 9999 min
...
8	$PL1$	ramp 1 and dwell 1 output power limit	0.0~100%
9	$PL2$	ramp 2 and dwell 2 output power limit	0.0~100%
...

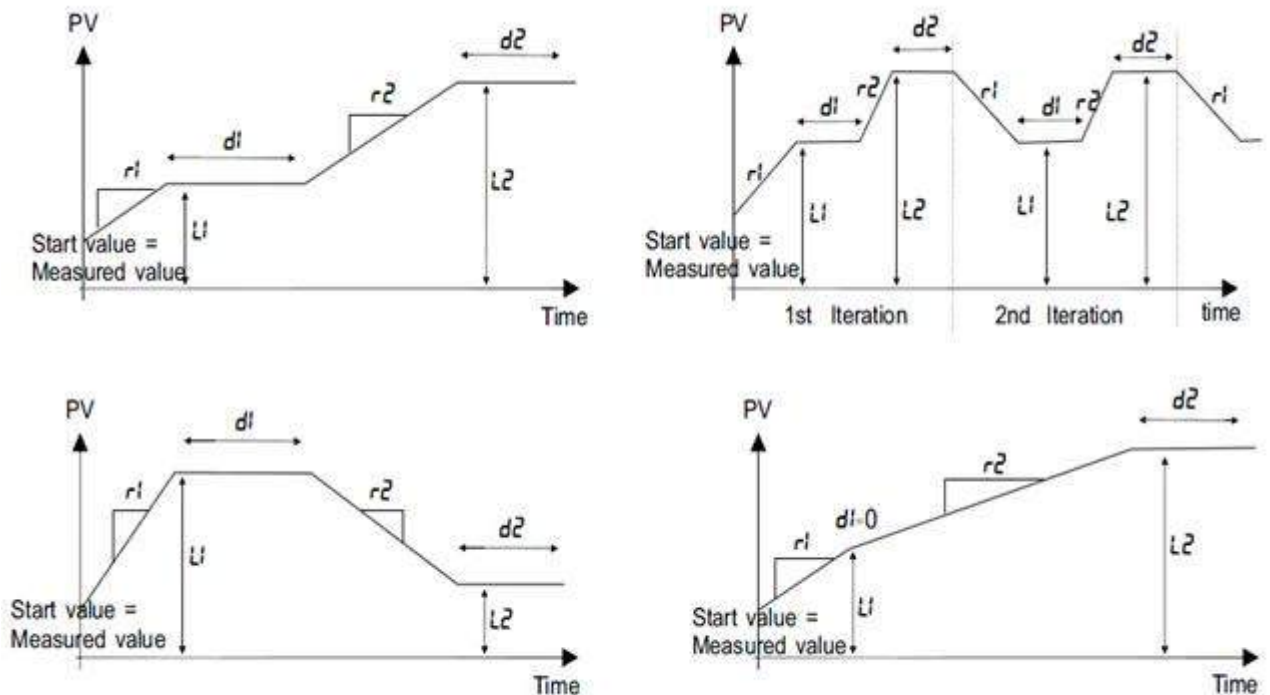

Program Examples

Set Bottom Temperature Controller

PV: Display window of actual temperature.

SV: Display window of setting temperature.



Press the **SET** button of Bottom temperature control instrumentation for 1 seconds, then the **PV** window to show **SU**.



The **SV** window to show current setting temperature, And the adjustable number flashes. Press key \wedge \vee to adjust temperature,, Press key $<$ to modify the value.



After the setted , Press the **SET** button for 1 seconds, save the current temp.



Rework Operation Steps

1、be all set

① Fixed motherboard



② shift sensor , sensor press close to BGA chip.



③ Adjust the height of heating head with adjustment knob (Prompt: BGA chip in the middle of heating head , heating head away from BGA chip \geq 2CM.)

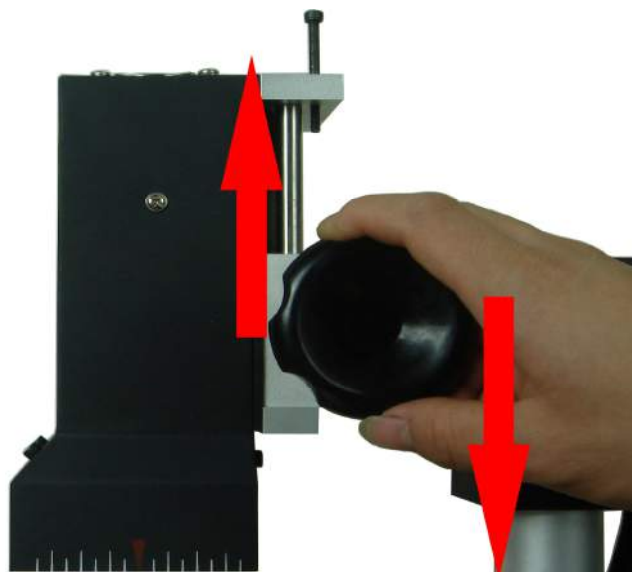

2、Start heating

1、 Select the appropriate temperature program segment, and then press the start switch.

In the operation can press the stop switch, stop operating.



2、 After the program runs, automatic alarm (8 Seconds) , and automatically cut off the heating power, this time you can check the following solder ball is completely liquefied, BGA chips should be subject to settlement, floating state .

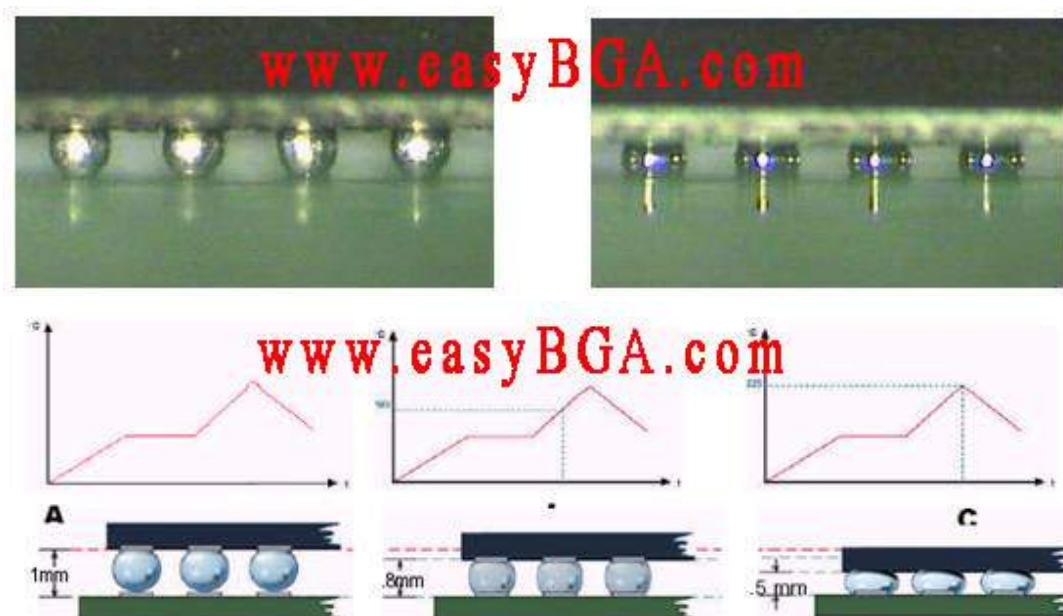

3、 Rework completed

- 1、 Moving Heating head and Sensor ,open the Upper fan Switch.
- 2、 Remove motherboard , Clear insulating tape !
- 3、 BGA Rework Station Cooled ,Then close Total Power !

Warning:

- If BGA Rework Station NO Cooling , Do not close the Total Power !
- When the temperature is not cooled, do not touch heating module!

Prompt

- 1、 Installed the equipment in stable work platform to use where the air mobility should be small as possible .Avoid it closing to air conditioners, fans and the other outlet.
- 2、 **ACHI® IR6500** Rework Station sensor Direct contact with motherboard, So Temperature display is Actual temperature。
- 3、 In order to avoid damage to the motherboard capacitor, SO use insulation tape please , Maintenance completed ,then Removal of insulation tape , So as to avoid short-circuit !
- 4、 After removal of BGA chip , PCB Bonding Pad Need to clean up , Avoid cold solder joint See BGA chip tin completely liquefied, Then To move the BGA chip, So as to avoid Bonding Pad Damage !
- 5、 BGA chips should be subject to settlement, floating state Prohibited in all solder ball did not fully liquefied, by force if removal of chips, so as to avoid pad off, chip or motherboard scrap!
- 6、 To improve success rate of Rework , PCB and chips need drying and processing in principle, PCB board or chip moist heat process will occur in the burst phenomenon, the Rework process may hear the blasting sound of a minor。 According to actual situation Please, self-control.
- 7、 PCB board heating time is too long or repeated several times the surface heating will lead to discoloration.
- 8、 Users from modifying temperature parameters, Please use scrap PCB tested, Heating whole time about 10 seconds before the end of solder balls should be fully liquefied, f the liquefaction advanced or delayed,, ! Should be regulating up/down the temperature setting. So as to avoid heat damage to chips or low-temperature sealing-off。
- 9、 The factory equipped with two sets of programmable temperature control table used parameters:

PTN-1: Lead Rework

PTN-2: Lead-Free Rework

Rework temperature curve to set examples					
Lead Sn63Pb37					
PTN- 1					
r1	1	L1	85	d1	70
r2	1	L2	150	d2	35
r3	1	L3	190	d3	50
r4	END	Hb	230		
Lead-Free					
Sn96.5Ag3Cu0.5					
PTN- 2					
r1	1	L1	85	d1	80
r2	1	L2	140	d2	60
r3	1	L3	220	d3	65
r4	END	Hb	230		

1/The meaning of “Hb”:

“Hb” means the max heating temperature of the upper heating. We set the max temperature at 230°C according to the max temperature of lead-free Rework and other technical reasons. **The data needn't to be changed.**

2/The meaning of “r1” “L1” “d1” “r2” “L2” “d2” “r3” “L3” “d3”

Please pay attention to The following pictures and tables:

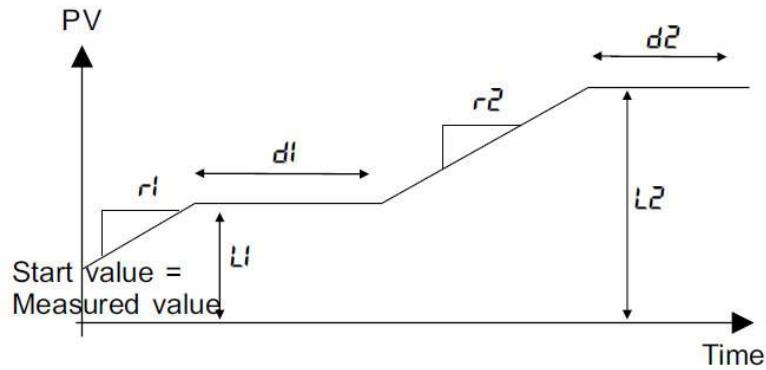

S.N.	Mnemonic	Parameter	Adjustable Range
1	r1	Ramp Rate 1	1
2	L1	Target Setpoint 1	0~230、End
3	d1	Dwell Time 1	0~9999sec
4	r2	Ramp Rate 2	1
5	L2	Target Setpoint 2	0~230、 End
6	d2	Dwell Time 2	0~9999sec
7	r3	Ramp Rate 2	1
8	L3	Target Setpoint 2	0~230、 End
9	d3	Dwell Time 2	0~9999sec
...
	Hb		230

Rework temperature curve to set examples					
Lead Sn63Pb37					
PTN- 1					
r1	1	L1	85	d1	70
r2	1	L2	150	d2	35
r3	1	L3	185	d3	50
r4	END	Hb	230		
Lead-Free Sn96.5Ag3Cu0.5					
PTN- 2					
r1	1	L1	85	d1	60
r2	1	L2	140	d2	45
r3	1	L3	170	d3	25
r4	1	L4	220	d4	50
r5	END	Hb	230		

3/ Please check Rework station surrounding environment, as far as possible away from the air outlet and other sources.

4/ Do not open upper fan in the welding process,

5/ Just remember that:

The max temperature of lead rework is approximately 183 °C,
(Reflow temp:185°C~190°C , Reflow time: 10 Sec)

that of lead free is approximately 217 °C.
(Reflow temp:220°C~225°C Reflow time: 15 Sec)

6/ No matter you click "Run" in the IRSOFT or Push the “start switch” on the control board, Rework station will be autorun current program segment in the Temperature Controller!

So you must Select the appropriate temperature program segment in the “PTN ”windows, or You can download IRSOFT’data to the controller, covered, then run.

